

# Full HD Time Lapse Camera TX-164

The Declaration of Conformity for this device is under the Internet link: [www.technaxx.de/](http://www.technaxx.de/) (in bottom bar "Konformitätserklärung"). Before using the device the first time, read the user manual carefully.

Service phone No. for technical support: 01805 012643 (14 cent/minute from German fixed-line and 42 cent/minute from mobile networks).

Free Email: [support@technaxx.de](mailto:support@technaxx.de)

The support hotline is available Mon-Fri from 9 am to 1 pm & 2 pm to 5 pm

Keep this user manual for future reference or product sharing carefully. Do the same with the original accessories for this product. In case of warranty, please contact the dealer or the store where you bought this product. **Warranty 2 years**

***Enjoy your product \* Share your experience and opinion on one of the well-known internet portals***

## Contents

Features .....	1
Product overview .....	2
Power supply .....	3
Inserting the memory card .....	3
Basic Operations.....	4
Time lapse setting .....	5
System Setup .....	7
Mounting.....	10
Download Files to a computer (2 ways) .....	11
Technical specifications .....	12
Warnings.....	13

## Features

- Time lapse camera battery operated for indoor and outdoor use
- Ideal for time lapse recordings of constructions sites, house building, plant growth (garden, orchard), outdoor shots, security monitoring, etc.
- Coloured time-lapse recordings during the day; Time-lapse recordings at night with high brightness additional by built-in LED (range ~18m)
- Full HD video resolution 1080P/ Picture resolution 1920x1080pixel
- 2.4" TFT LCD display (720x320)
- 1/2.7" CMOS sensor with 2MP and low light sensitivity
- Wide angle lens with 110° field of view
- Select functions: time lapse photo, time lapse video, photo or video
- Built-in microphone & speaker
- MicroSD card\*\* up to 512GB (\*\*not included in delivery)
- Camera protection class IP66 (dust proof & splash water proof)

## Product overview

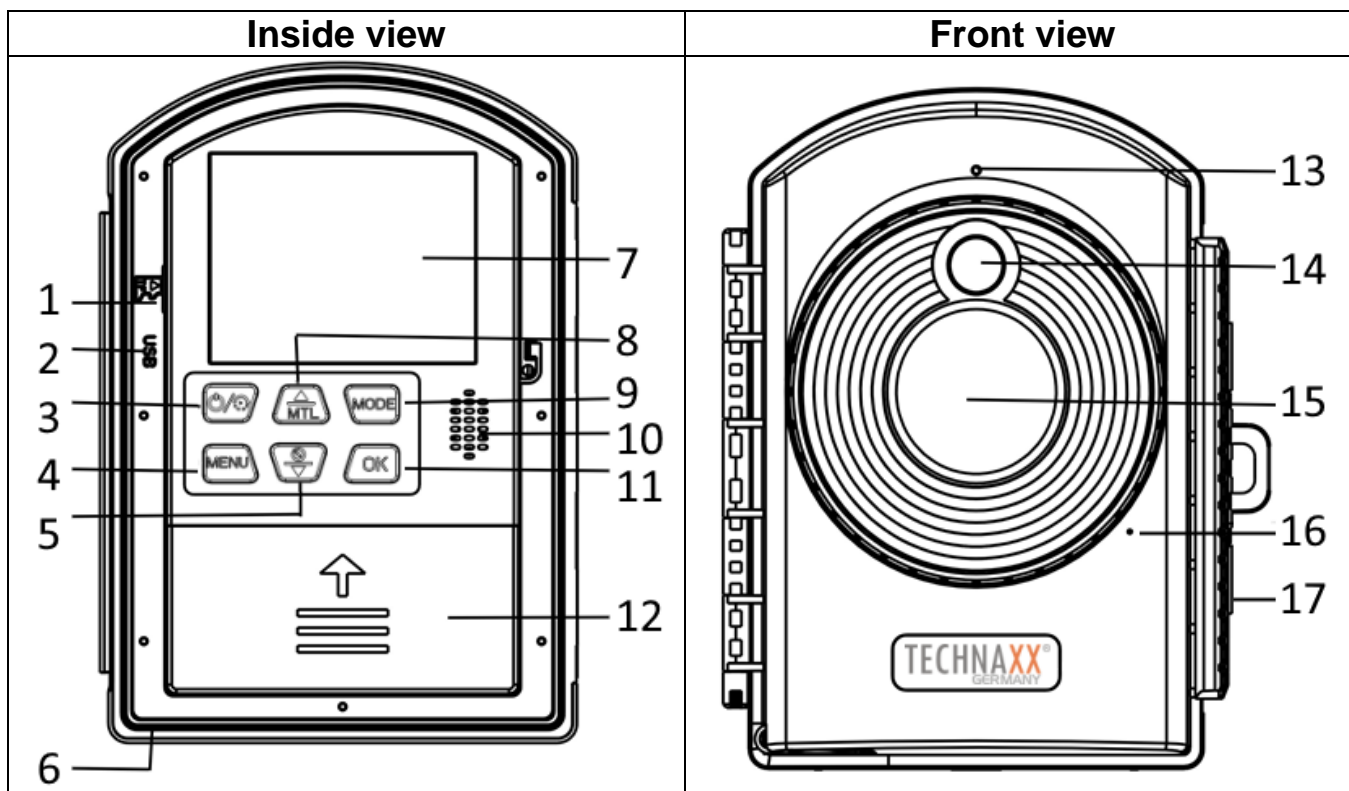

1	MicroSD card slot	10	Loudspeaker
2	MicroUSB port	11	OK button
3	Power button /Time lapse Button start/stop	12	Battery compartment (4x AA)
4	Menu button	13	Status indicator
5	Down button /Selfie button	14	LED light
6	DC Jack (6V /1A)	15	Lens
7	Display screen	16	Microphone
8	Up button / Manual time lapse button	17	Locking clamp
9	Mode button / Right button		

## Power supply

→ Insert 12x pieces of 1.5V AA batteries\* (\*included) in the correct polarity before first use. → Open the battery compartment on the left (12) to insert 4xAA batteries. Remove the battery cover on the right to insert 8xAA batteries.

### Extended Information for Power supply

- The device does not work with a battery voltage lower than 4V.
- You can use rechargeable batteries. Attention: Shorter working time!
- If you use the DC Jack as power supply the inserted batteries will not be charged. Please remove the batteries from the device.
- The battery life using standard non-rechargeable AA batteries with default time lapse photo mode and a period of 5minutes will be: about 6 months with 288photos/day (12xAA batteries installed).

**Open the battery compartment on the right side.**

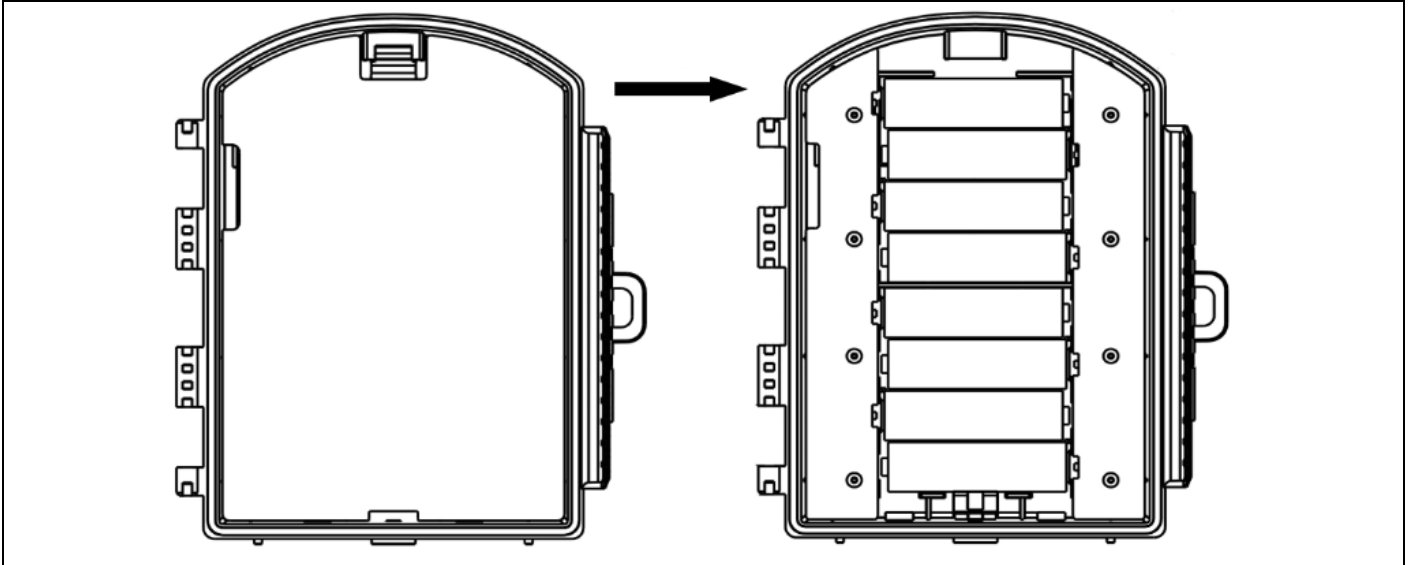

## Inserting the memory card

● The camera has no built-in memory, therefore insert a formatted MicroSD card\*\* up to 512GB (\*\*not included) for saving files. We suggest to use class 10 or higher.

**Attention:** Do not insert the MicroSD card forcibly; refer to the marking on the camera. The MicroSD card should have same temperature like the ambient temperature.







- If the capacity of MicroSD card is full, the camera will stop recording automatically.
- Press the edge of the card gently to pop-out the MicroSD card.

**Info:** ● Cards up to 32GB must be formatted in FAT32.

- Cards of 64GB or more must be formatted in exFAT.

# Basic Operations

## Key assignment

Button		Function
Power Button / Time lapse Button (3)		Long press to turn on/off; After starting up, press the button to start the set automatic time lapse mode for recording. To stop the recording press again.
MENU Button (4)		Enter/exit menu
MODE Button (9)		Switch between camera mode / video mode / playback mode. In some menu used as rightward.
OK Button (11)		Manual record / OK confirmation
UP Button / MTL Button (8)		Upward / Manual time lapse photo shortcut
DOWN Button / Selfie Button (5)		Downward / Self timer



## Mode

You can use the Mode button to switch between 3 modes:

- Manual photo mode
- Manual video mode
- playback mode

Press the MODE button (9) to switch between mode.

At the top left of the screen you can see which mode is active.

	Photo Mode	For taking photos manually.
	Video Mode	For recording video manually.
	Playback Mode	For playing the recorded files.

→ **Take photo manually:** Press the MODE button (9) to switch to photo mode. Press OK button (11) to take a picture.

→ **Record Video manually:** Press the MODE button (9) to switch to video mode. Press OK (11) to start recording, and press OK (11) again to stop recording.

→ **Playback:** Press the MODE button to switch to the playback interface, press the UP/DOWN button (5/8) to browse the saved photos and videos. When playing back the video, press the OK button (11) to play, press the OK button (11) again to pause, and press the MENU button (4) to stop playing. Press the MODE button (9) again to exit playback mode.

## Playback Menu

Delete the current photo or video	Delete the current photo or video	Options: [Cancel] / [Delete] → Press OK to confirm
Delete all files	Delete all photo and video files saved on the memory card.	Options: [Cancel] / [Delete]
		→ Press OK (11) to confirm
Activate slide show	Playback the photos in slide way.	Each photo display 3 sec.
	→ Press OK button (11) to stop playing.	
Write protect	Lock the file. It can avoid accident deletion.	Options: [Write-protect current file] / [Write-protect all files] / [Unlock current file] / [Unlock all files].
	→ Select and press OK button (11) to confirm.	

## Time lapse setting

You can set automatic or manual time-lapse for time-lapse shooting.

### Set automatic time-lapse shooting



Press the POWER button (3) once for starting up. You will now see the main screen. Click the MENU button (4). Afterwards press the DOWN button (8) to switch to MODE option. Press OK button (11) to open the menu. You can now choose between 4 modes.

**Timelapse (Photo)** is time lapse for photo, can be set to take 1 photo every 3 seconds to 24 hours, and automatically connect photos to generate time-lapse AVI videos in real time.

**Timelapse (Video)** is time lapse for video, it can be set to record a short video of 3 second to 120 seconds every 3 seconds to 24 hours, and automatically connect to AVI video.

**Timing Photo** can be set to take 1 photo every 3 seconds to 24 hours.

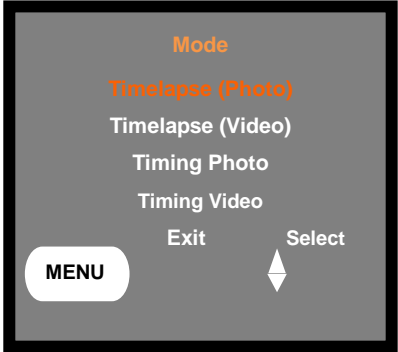
**Timing Video** can be set to record a video from 3 seconds to 120 seconds every 3 seconds to 24 hours.

		
<p>1. Select the Mode</p>	<p>2. Select the capture interval. By using UP/DOWN button (5/8) and MODE button (9) for right.</p>	<p>3. Select the day by using the MODE button (9). Enable/disable the day by using up or down button</p>

Press OK button (11) to set the day of the week and capture interval. After you finished the setting, return to the main screen by pressing the MENU button (4). Then short press the POWER button (3). The screen will prompt a 15-second countdown. After the countdown is over, it will enter the recording mode and the camera will shoot photos/videos according to the capture interval you set. Short press the POWER button (3) again to stop time lapse shooting.

### Set manual time-lapse shooting (Stop-motion)

- After starting the photo mode is activated by default. Press the UP / MTL button (8) to start manual time-lapse recording. Press the OK button (11) to take a photo. Repeat this until your stop motion recording is complete. Then press the UP / MTL button (8) again to end the manual time-lapse recording. The photos are automatically merged into a video.
- After starting up, press the MODE button (9) to switch to the video mode, press the UP /MTL button (8) to enter the manual time-lapse video shoot, press OK button (11) to start recording. The video will record for the set video length. Repeat this until your manual time-lapse video is complete. When you finish taking videos, press UP / MTL button (8) again to stop the manual time-lapse video. The videos are automatically merged into one video.

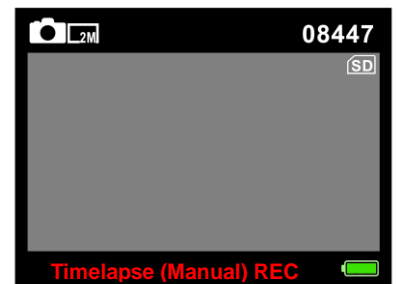

## System Setup

→ Press the POWER button (3) once for starting up, click the MENU button (4) to set/change the camera settings.

→→ Press UP/DOWN button (5/8) to scroll through all menu. Then press OK button (11) to enter the options interface.

→→→ Press UP/DOWN button (5/8) to scan all options. And press OK button (11) to confirm options.

→→→→ Press MENU button (4) again to turn back to last menu or exit the setup menu.

### Setup menu and function as below

**Setting:** The overview shows the important information that has been set so far: Set mode, interval time, current battery power, microSD card available space.

**Mode:** [Timelapse Photo] (default) / [Timelapse Video] / [Timing Photo] / [Timing Video]. → Select and press OK button to confirm.

Set the working mode	Timelapse Photo mode (default)	Camera takes pictures every set period and combines them to a video.
	Timelapse Video mode	Camera takes video every set period for the set video length and combines them to a video.
	Timing Photo mode	Camera takes pictures every set period and saves the picture.
	Timing Video mode	Camera takes video every set period for the set video length and saves the video.

**LED:** Set the Led [On]/[Off] (default). This can help to light up dark environment.

→ Select and press OK button (11) to confirm.

● [ON] During the night, the LED will turn on automatically, to provide necessary light for taking pictures/videos. This makes it possible to take pictures at a distance about 3–18m.

● However, reflective objects such as traffic signs can cause overexposure if they are located within the recording range. In night mode, the pictures just can display white and black.

**Exposure:** Set the exposure. [+0.3 EV]/[+0.2 EV]/ [+0.1 EV] / [+0.0 EV] (default) / [-1.0 EV]/[-2.0 EV]/[-3.0 EV].

→ Select and press OK button (11) to confirm.

**Language:** set the language display on screen: [English] / [German] / [Danish] / [Finnish] / [Swedish] / [Spanish] / [French] / [Italian] / [Dutch] / [Portuguese].

→ Select and press OK button (11) to confirm.

**Photo Resolution:** Set the image resolution: the bigger the resolution → the higher the sharpness! (It will take bigger storage either.)

[2MP: 1920x1080] (default) / [1M: 1280x720]

→ Select and press OK button (11) to confirm.

**Video Resolution:** [1920x1080] (default) / [1280x720]. → Select and press OK button to confirm. Set the video resolution: the bigger the resolution → the shorter the recording time.

→ Select and press OK button (11) to confirm.

**Frequency:** Set the light source frequency to match frequency of electricity supply in local region to prevent interference. Options: [50Hz] (default) / [60Hz].

→ Select and press OK button (11) to confirm.

**Video length:** Set the duration of recording a video clip. Options: 3 sec. – 120 sec. (default is 5 sec.)

→ Select and press OK button (11) to confirm.

**Photo Stamp:** stamp the date & time on the photos or not. Options: [Time & date] (default) / [Date] / [Off].

→ Select and press OK button (11) to confirm.



**Target Recording Time 1 & 2:** Set the monitoring time of the camera, you can set the specific time period for the camera to record. You can set the start time and end time of camera recording. After the setting is completed, the camera will only record during the set time period every day, and it will be on standby at other times.

Options: [On] / [Off]

To set the time use UP, DOWN and MODE (left) button (5/8/9).

**Beep Sound:** [On] / [Off] (default). → Select and press OK button to confirm. Open den Beep sound menu to turn On or Off the confirmation sound of the buttons.

**Endless Capture:** [On] / [Off] (default). → Select and press OK button to confirm.

If you activate Endless Capture the device will capture photo or/and video, depending on the mode you choose, until the storage of the MicroSD card is reached. When the storage is full the recording will move on. Which means that the oldest file (photo/video) will be deleted, every time a new photo/video is recorded.

**Date format:** Date format: select between [dd/mm/yyyy] / [yyyy/mm/dd] (default) / [mm/dd/yyyy].

Press UP/DOWN button (5/8) to adjust the values. → Select and press OK button (11) to confirm.

**Time & Date:** To set time & date use up, down and mode (left) button to switch the values and the position.

→ Select and press OK button (11) to confirm.

**Audio recording:** Camera will record audio when recording video. Options: [On] (default) / [Off].

→ Select and press OK button (11) to confirm.

**Reset Settings:** [Yes] / [No] (default). → Select and press OK button (11) to confirm. Restore the camera to factory default settings.

**Version:** Look up the Firmware information of the camera.

**Format Memory Card:** [Yes] / [No] (default). → Select and press OK button (11) to confirm.

**Attention:** Formatting the memory card will delete all data permanently. Before using a new memory card or a card that has been used in another device previously, please format the memory card.

**Info:** ● Cards up to 32GB must be formatted in FAT32.

● Cards of 64GB or more must be formatted in exFAT.

## Mounting

**Caution:** If you drill a hole in the wall, please make sure that power cables, electrical cords and/or pipelines are not damaged. When using the supplied mounting material, we do not take the liability for a professional installation. You are entirely responsible to ensure that the mounting material is suitable for the particular masonry, and that the installation is done properly. When working at higher altitudes, there is danger of falling! Therefore, use suitable safeguards.

### Using the wall bracket

You can mount the Time-lapse camera permanently on a wall using the supplied wall bracket. Before mounting the camera you should ensure that all existing screws are tight.

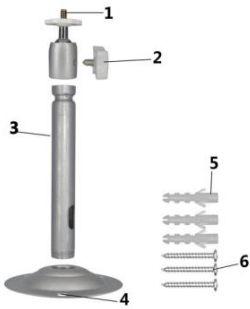
Components	Required tools	
<ol style="list-style-type: none"><li>1. Tripod screw</li><li>2. Bracket fixing screw</li><li>3. Bracket support rod</li><li>4. Drill holes</li><li>5. Wall plugs</li><li>6. Screws</li></ol>	<ul style="list-style-type: none"><li>● Drill</li><li>● 6 mm masonry/concrete drill bit</li><li>● Phillips head screwdriver</li></ul>	

### Install Steps

- Mark the drill holes by holding the foot of the wall bracket at the desired mounting location and marking the hole positions.
- Use a drill with a 6 mm drill bit to drill the required holes and insert the plugs and insert the wall plugs flush with the wall.
- Screw the wall bracket to the wall using the supplied screws.
- Mount the camera on the tripod screw and screw the camera a little way on (about three turns).
- Turn the camera in the desired direction and lock it with the lock nut.
- To move the camera into its final position, undo the two pivot bolts a little, position the camera and fix the position by tightening the two pivot bolts.

### Using the Mounting Belt

Use the mounting belt to mount the Time-lapse camera to any object (e.g. tree) you can get the belt around.

Pull the belt through the rectangular oblong holes on the back and put the belt around the desired object. Now fasten the belt.

## Using the Rope (Elastic cord)

Use the Rope to mount the time-lapse camera to any object. Pull the rope through the round holes on the back and put the rope around the desired object. Now make a loop or knot to tighten the Rope.

## Download Files to a computer (2 ways)

- Inserting the MicroSD card into a card reader.
- Connecting the camera to a computer using the supplied MicroUSB cable.

### Using a Card Reader

→ Pop-out the memory card from the camera and insert it into a card reader adapter. Then connect the card reader to a computer.

→→ Open [My Computer] or [Windows Explorer] and double-click the removable disk icon that represents the memory card.

→→→ Copy image or video files from the memory card to your computer.

### Connecting the camera to a PC by the MicroUSB Cable

→ Connect the camera to the computer via MicroUSB cable. Switch on the camera, the screen will display „MSDC”.

→→ Open [My Computer] or [Windows Explorer]. A removable disk appears in the drive list. Double-click the "Removable Disk" icon to view its contents. All files are stored in the folder named „DCIM”.

→→→ Copy the photos or files to your computer.

### NOTES on Cleaning

Before cleaning the device, disconnect it from the power supply (remove batteries)! Only use a dry cloth to clean the exterior of the device. To avoid damaging the electronics, do not use any cleaning fluid. Clean the eyepieces and/or lenses only with a soft, lint-free cloth, (e.g. microfibre cloth). To avoid scratching the lenses, use only gentle pressure with the cleaning cloth. Protect the device from dust and moisture. Store it in a bag or box. Remove the batteries from the device if it is not used for a longer time

## Technical specifications

Image sensor	1/ 2.7" CMOS 2MP (low-light)
Display	2.4" TFT LCD (720x320)
Video resolution	1920x1080/25fps, 1280x720/30fps,
Photo resolution	2MP (1920x1080), 1MP (1280x720)
File format	JPEG/AVI
Lens	f=4mm, F/NO1.4, FOV=110°, Auto IR filter
LED	1x 2W white LED (high power) ~18m range; 120° (Additional light only in darkness)
Exposure	+3.0 EV ~-3.0 EV in increments of 1.0EV
Video length	3 sec.– 120sec. programmable
Recording distance	Daytime: 1m up to infinitive, Night time: 1.5–18m
Time lapse interval	Custom: 3 seconds up to 24 hours; Mon-Sun
Auto-distinguish images	Color images in daytime/black & white night images
Microphone & speaker	Built-in
Connections	MicroUSB 2.0; barrel connector 3.5x1.35mm
Storage	External: MicroSD/HC/XC** card (up to 512GB, Class10) [**not included in delivery]
Power supply	12x AA batteries* (*included); external DC6V power supply** at least 1A [**not included in delivery]
Standby time	~6 months, depending on settings and used battery quality; Photos 5 minutes interval, 288 photos / day
Device language	EN, DE, SP, FR, IT, NL, FI, SE, DK, PO
Working temperature	-20°C up to +50°C
Weight & Dimensions	378g (without batteries) / (L) 12.5 x (W) 8 x (H) 15cm
Package contents	Full HD Time Lapse Camera TX-164, MicroUSB cable, Mounting belt, Rope, Wall bracket, 3x screws & 3x dowels, 12x AA batteries, User Manual

## Warnings

- Do not attempt to disassemble the device, it may result in short-circuit or even damage.
- The camera will be short-circuiting influenced by environment temperature and humidity. Notice protection for the camera when using it outdoor.
- Do not drop or shake the device, it may break internal circuit boards or mechanics.
- Batteries should not be exposed to excessive heat or direct sunlight.
- Keep the device away from little children.
- The device will be hot after using for too long time. This is normal.
- Please use the accessory provided.



Products marked with this symbol meet all applicable community regulations of the European Economic Area.

Technaxx Deutschland GmbH & Co KG has issued a "declaration of conformity" in accordance with the applicable directives and relevant standards. has been created. This can be viewed at any time upon request.



**Security and Disposal Hints for Batteries:** Hold children off batteries. When a child swallowed a battery go to a doctors place or bring the child into a hospital promptly! Look for the right polarity (+) and (-) of batteries! Always change all batteries. Never use old and new batteries or batteries of different types together. Never short, open, deform or load up batteries! **Risk of injury!** Never throw batteries into fire! **Risk of explosion!**



**Hints for Environment Protection:** Packages materials are raw materials and can be recycled. Do not disposal old devices or batteries into the domestic waste. **Cleaning:** Protect the device from contamination and pollution (use a clean drapery). Avoid using rough, coarse-grained materials or solvents/aggressive cleaner. Wipe the cleaned device accurately. **Important Notice:** Should battery fluid leak from a battery, wipe the battery case with a soft cloth dry. **Distributor:** Technaxx Deutschland GmbH & Co.KG, Kruppstr. 105, 60388 Frankfurt a.M., Germany

## **FCC Statement**

This device complies with part 15 of the FCC Rules. Operation is subject to the following two conditions:

- (1) This device may not cause harmful interference, and
- (2) this device must accept any interference received, including interference that may cause undesired operation.

Any changes or modifications not expressly approved by the party responsible for compliance could void the user's authority to operate the equipment.

NOTE: This equipment has been tested and found to comply with the limits for a Class B digital device, pursuant to Part 15 of the FCC Rules. These limits are designed to provide reasonable protection against harmful interference in a residential installation. This equipment generates, uses and can radiate radio frequency energy and, if not installed and used in accordance with the instructions, may cause harmful interference to radio communications. However, there is no guarantee that interference will not occur in a particular installation.

If this equipment does cause harmful interference to radio or television reception, which can be determined by turning the equipment off and on, the user is encouraged to try to correct the interference by one or more of the following measures:

- Reorient or relocate the receiving antenna.
- Increase the separation between the equipment and receiver.
- Connect the equipment into an outlet on a circuit different from that to which the receiver is connected.
- Consult the dealer or an experienced radio/TV technician for help.

The device has been evaluated to meet general RF exposure requirement. The device can be used in portable exposure condition without restriction.

## **US Warranty**

Thank you for your interest in the products and services of Technaxx Deutschland GmbH & Co.KG. This Limited Warranty applies to physical goods, and only for physical goods, purchased from Technaxx Deutschland GmbH & Co.KG.

This Limited Warranty covers any defects in material or workmanship under normal use during the Warranty Period. During the Warranty Period, Technaxx Deutschland GmbH & Co.KG will repair or replace, products or parts of a product that proves defective because of improper material or workmanship, under normal use and maintenance.

The Warranty Period for Physical Goods purchased from Technaxx Deutschland GmbH & Co.KG is 1 year from the date of purchase. A replacement Physical Good or part assumes the remaining warranty of the original Physical Good or 1 year from the date of replacement or repair, whichever is longer.

This Limited Warranty does not cover any problem that is caused by:

- conditions, malfunctions or damage not resulting from defects in material or workmanship

To obtain warranty service, you must first contact us to determine the problem and the most appropriate solution for you.

Technaxx Deutschland GmbH & Co.KG, Kruppstrasse 105, 60388 Frankfurt am Main, Germany

\* [www.technaxx.de](http://www.technaxx.de) \* [support@technaxx.de](mailto:support@technaxx.de) \*